



ISSN: 0976-3376

Available Online at <http://www.journalajst.com>

ASIAN JOURNAL OF  
SCIENCE AND TECHNOLOGY

Asian Journal of Science and Technology  
Vol. 08, Issue, 12, pp.7010-7016, December, 2017

## RESEARCH ARTICLE

### THEORY OF 3-FOLDS 5-DIMENSIONAL UNIVERSE

\*Yogesh Vishwanath Chavan

Dy. Manager, SU-30 MKI Final Assembly, Hindustan Aeronautics Ltd., Nasik Div., Maharashtra, India

#### ARTICLE INFO

##### Article History:

Received 06<sup>th</sup> September, 2017  
Received in revised form  
24<sup>th</sup> October, 2017  
Accepted 29<sup>th</sup> November, 2017  
Published online 29<sup>th</sup> December, 2017

##### Key words:

Particle Physics,  
Standard Model,  
Dark Matter,  
Dark Energy.

#### ABSTRACT

In this Theory, the equivalence between “Mass” and “One Dimensional Imaginary Straight Line” is proved by embedding Mass on Imaginary Line. Also, based upon current experimental data, empirical formula is derived which gives upper limit on energy scale up to TeV with minimum size equal to value of charge (Q). These both concepts with The Standard Model of Particle Physics are used to arrange particles (Fermions and Bosons) in 3 Folds way in 4<sup>th</sup> Imaginary Space. Mass of Fermions, % Distribution of Matter, Relation between Inertial/Gravitational Mass with Gluon is shown by self explanatory figures. Nature of Graviton, Photons and Dark Energy is discussed, here. Finally, matter-Antimatter Asymmetry through 5<sup>th</sup> Dimensional Rotation is proved.

Copyright©2017, Yogesh Vishwanath Chavan et al. This is an open access article distributed under the Creative Commons Attribution License, which permits unrestricted use, distribution, and reproduction in any medium, provided the original work is properly cited.

#### INTRODUCTION

In the 17th century, scientists came to the conclusion that chemical elements such as hydrogen, oxygen, and copper were composed of atoms. A chemical element, hydrogen say, was thought to consist of a single type of atom. And chemical methods made it possible to determine the approximate size of such an atom:  $10^{-8}$  cm that means, one billion hydrogen atoms stacked on top of one another would reach a height of around 10 cm. Today we know that, normal matter is made up of quarks (which are the building blocks of the atomic nucleus), and electrons. The Standard Model describes the fundamental interactions in a simple form. The interactions are the chromo dynamic force (QCD), which acts between quarks, and the electroweak force, which acts between quarks and leptons, such as electrons. Today's Standard Model of elementary particles, which consists of the theory of the electroweak interaction plus QCD, seems to describe the whole of physics. In the Standard Model, leptons and quarks are points, singularities in space. Can such infinitely small points even have a mass? In order to introduce leptons and quarks masses, physicists invented a hypothetical field which is able to give mass to these particles. The field is called the Higgs field (Spin=0) after the theoretician Peter Higgs, who introduced this field.

*(But in this model, no masses can be calculated. The unknown masses are replaced by unknown parameters describing the interaction of the Higgs field with fermions.)*

The Large Hadron Collider at CERN announced results consistent with the Massive Higgs particle (God Particle, Spin=0) on July 4, 2012. Could this theory prove to be a last and thereby final truth? There are a number of important questions not answered by this theory, like: Constant Mass of Particles (Fermions), Matter-Antimatter Asymmetry, Nature of Particles related to 24% Gravitating Dark Matter & around 72% Repulsive Dark Energy, Union of Einstein's Gravity Force (manifestation of the curvature of space and time; Continuous Nature of Space-Time) with Physical Forces (Particle Concept; Quanta Nature) like EMF, SNF & WNF of Standard Model, origin of 3 generations or families of Fermions viz. Quarks & Leptons etc.

#### Three Postulates and equivalence of mass with imaginary straight line

In this theory, instead of considering Grand Unification of Forces at around  $10^{18}$  GeV; it is showed that the Universe itself came into existence by “One (Unified) Fundamental Particle” at TeV Range (Not in Big Bang Rapid Inflation Way but, definitely in systematic unfolded way). The theory is based upon three postulates, viz.

- Current Experiments limit on size of leptons and quarks up to  $10^{-19}$  m (Even at this distance, no inner structure was found for leptons and quarks).
- “Empirical Formula” which is derived by me. It connects 4 main fundamental constants of nuclear physics as well as satisfies above first experimental aspect.

\*Corresponding author: Yogesh Vishwanath Chavan

Dy. Manager, SU-30 MKI Final Assembly, Hindustan Aeronautics Ltd., Nasik Div., Maharashtra, India.

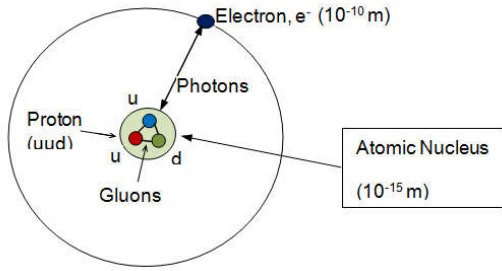

Fig. 1. Hydrogen Atom

$h = k * c * Q = m * V * \lambda = m * V * (2\pi * r)$  Where;  $\{k/(2\pi)\}$   
 $\Leftrightarrow m, c \Leftrightarrow V$  and  $Q \Leftrightarrow r$   
 $h = \text{Planck's constant} = 6.626 * 10^{-34} \text{ J. Sec}$   
 $k = \text{Boltzmann's Constant} = 1.38 * 10^{-23} \text{ Kg} \ \& \ \{k/(2\pi)\} =$   
 Maximum Mass of Particle = 1.23 TeV  
 $c = \text{Speed of Light} = 2.997 * 10^8 \text{ m/Sec.}$   
 $Q = \text{Charge on Particle} = \text{Minimum Size of Particle} = 1.602 * 10^{-19} \text{ m.}$

Table 1. The Standard Model of Particle Physics

The Standard Model		<i>(Matter &amp; Energy; E = m * c<sup>2</sup>)</i>			
<i>Forces &amp; Boson Particles</i>		<i>Fermion Particles (Spin = +/- 1/2)</i>			
Strong Nuclear Force (SNF);	Gluon (Spin = 1);	<i>3 Generations of Quarks (Always confined inside Hadrons)</i>			
	Charge = 0	u	c	t	
	Massless Particle;	(Up Quark) Charge = + 2/3	(Charm Quark) Charge = + 2/3 Q	(Top Quark) Charge = + 2/3 Q	Mass = 174.3 GeV
Electromagnetic Force (EMF)	Photon (Spin = 1);	d	s	b	
	Charge = 0	(Down Quark) Charge = - 1/3	(Strange Quark) Charge = - 1/3 Q	(Bottom Quark) Charge = - 1/3 Q	Mass = 4-4.4 GeV
	Massless Particle	Mass = 3-9 MeV	Mass = 70-170 MeV	Mass = 4-4.4 GeV	
Weak Nuclear Force (WNF)	W <sup>+</sup> , W <sup>-</sup> , Z	<i>3 Generations of Leptons</i>			
	(3 Boson Particles)	e <sup>-</sup>	μ <sup>-</sup>	τ <sup>-</sup>	
	(Spin = 1)	(Electron)	(Muon)	(Tau)	
	Mass of W <sup>+/-</sup> = 80 GeV;	Charge = - Q	Charge = - Q	Charge = - Q	
	Mass of Z = 91 GeV	Mass = 0.51 MeV	Mass = 105.6 MeV	Mass = 1.78 GeV	
Gravitational Force (GF)	Graviton (Spin = 2);	ν <sub>e</sub>	ν <sub>μ</sub>	ν <sub>τ</sub>	
	Charge = 0	(Electron Neutrino)	(Muon Neutrino)	(Tau Neutrino)	
	Massless Particle?	Charge = 0	Charge = 0	Charge = 0	
		Massless Particle?	Massless Particle?	Massless Particle?	

(For every Fermion Particle; there exists its Anti-Particle with opposite charge.)

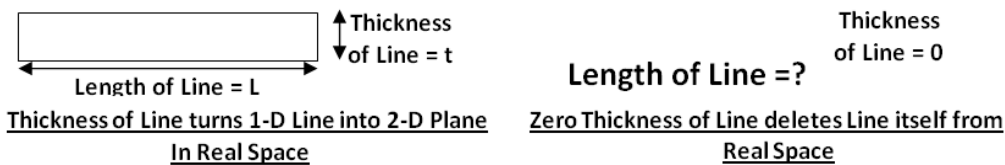

Fig. 2. Nature of One Dimensional Line in Real Space

The important thing about this formula is that for given experimental limit on minimum size of basic particles (which is equal to value of charge Q) and for limit on maximum speed of particle viz. speed of light, c; it gives limit on maximum mass of particle (k) in the range of TeV (What a Coincidence!). This coincidence tells us that the Universe must had started from the “One (Unified) Fundamental Particle” (Instead of one Unifying Force as in case of Grand Unification Theory) having above constants viz. h, k, c & Q in connected way. That means, if anyone wants to find the origin of each of these fundamental constants in separate way, then he has to look into the past i.e. darkness (if possible) before the creation of the Universe.

**Equivalence of Mass and Imaginary Line**

In String Theory, particles are defined in String Like manner (small one dimensional object) in Real Space with size equal to Planck Length around 10<sup>-33</sup> cm in order to avoid singularity which happens in case of point like object. However, here we have to accept 10 dimensions instead of our 4 dimensional space-time concept. But, when I attempted to define, “One Dimensional Line”; I came to realize that, for existence of such line in Real Space, it must has thickness which adds at least one more dimension in Real Space. Then, this thickness, itself spoils the definition of “One Dimensional line” in Real Space. Line with Zero Thickness is meaningless from point of view of Real Space (i.e. Line doesn’t exist in Real Space). In other words, “It is impossible to draw One Dimensional Line in Real Space”. While above thing doesn’t happen in case of “Imaginary Space”. Here, thickness of line (Imaginary Line) doesn’t spoil the definition of “One Dimensional line” in Imaginary Space.

This is because; one can’t measure imaginary thickness in terms of fixed scale like cm or m. Now, from Physics point of view, to draw any Line, you will require some Entity i.e. Amount of Matter or Mass. Then, from above Math’s point of view, Mass should never exist in Real Space because of No Existence of One Dimensional Line in Real Space. While in Imaginary Space, Mass should embed on Imaginary Line itself.

**“Mass is Equivalent to Length of Straight Imaginary Line”**

Thus, from Math’s and Physics, both points of view; it is easy to merge thickness of line into Imaginary Line itself. Here, zero Imaginary thickness (t=0) will never delete the Imaginary

Line {Length =  $iL$  = Amount of Matter to draw that Line;  $i = \sqrt{-1}$ } from Imaginary Space because of existence of Mass. Keeping in Mind of above 3 postulates and Tripartite nature of particles (3 Generations or families of Fermions), in this theory, the particles of Standard Model are arranged in 3 Folds way (Bottom Fold, Middle Folds & Top Fold) from TeV to approx. 0eV in 4<sup>th</sup> Imaginary Dimension (Imaginary Line  $\equiv$  Mass) i.e. instead of point like structure, all Fermion particles act like One Dimensional Straight Imaginary Line. These particles have no thickness, hence from our 3 Dimensional Real Space, we always look them as point like or structure less particles.

This Bottom Fold is again divided into two sub-folds to distinguish between (+2/3 Q Quarks) viz. Up, Charm, Top Quarks and (-1/3 Q Quarks) viz. Down, Strange, Bottom Quarks. Same (+2/3 Q) sub-fold of bottom fold is shared by top, charm & up quarks while same (-1/3 Q) sub-fold of bottom fold is shared by bottom, strange & down quarks. Here, masses of quarks are like mass parameter type and decrease in mass of next generation quark is because of expansion of the Universe into other folds above this bottom fold. In this theory, Quark Confinement is defined in terms of Side Gluon Fields which forces Quarks to move inward and prevents their escape from Hadrons or Masons. Mass of Hadron or Mason is because of "Tri-Color Charged Vector Boson Particle" made up of 3 Imaginary Lines at Middle of Bottom Fold (Spin = 0). Our Universe is called as 3 folds because during its expansion, it opens up in unfolded way like opening of layer of petals of flower (e.g. Lotus) from its bud. This theory also shows that, Bottom of Bottom Fold carries "4<sup>th</sup> type of Anti-neutrino" ( $\nu'_y \approx 40$  GeV) which yet to be discover.

**Description of 3 folds universe and nature of particles**

**Bottom Fold**

It includes particles made up of Quarks viz. Hadrons and masons; Gluons and Tri-Color Charged Particle.

**3 Folds 5-D Universe**

Mass of particle decreases from TeV to  $\approx 0$ eV in 4<sup>th</sup> Imaginary Dimension in Upward Direction and because of length of every fold of 3 Folds is Fixed, length of each Imaginary String Like Massive Particles defines Definite Value of that Particle Mass relative to it's Fold.

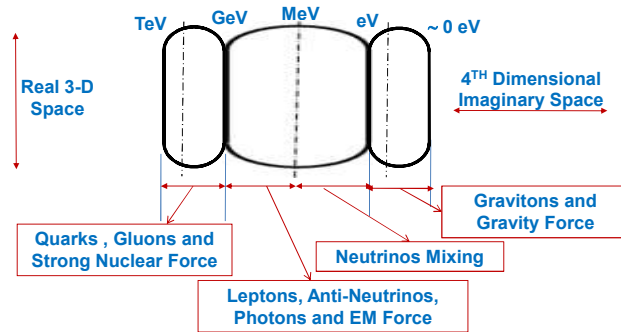

Fig. 3. Position of Particles (3 Folded Way) in 4<sup>th</sup> Dimensional Imaginary Space

**Creation of Universe in 3 Folds Way into 4<sup>th</sup> Dimension (Imaginary Space)**

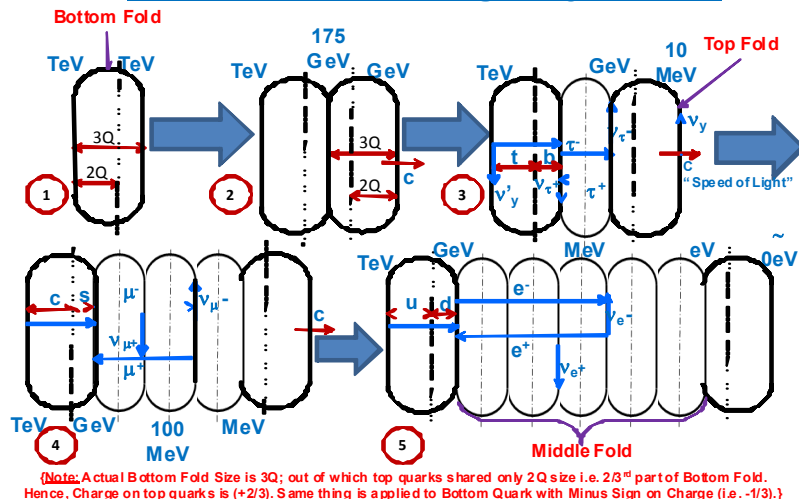

Fig. 4. Creation of Universe (3 Folds Way) in 4<sup>th</sup> Dimensional Imaginary Space

The Universe was started with “Bottom Fold” only, which doesn’t hold Gravitons (Spin = 2) Particles (carrier of Gravity force). It means at this first stage of the Universe, there was no Gravity force between Massive objects. It comes into existence after creation of Graviton particles. Thus, idea of Unification of Forces, itself is wrong.

particle; which is known as Wave-Particle Duality” in Quantum Mechanics. {When any string rotates in  $N^{\text{th}}$  Dimension, Every point on String should include all (N-1) Dimensions. For e.g. a pencil (String) attached to compass rotates in  $3^{\text{rd}}$  Dimension and draws a circle on paper (this circle includes all dimensions on paper i.e. two dimensions).

## Side Gluon Fields & Quark Confinement

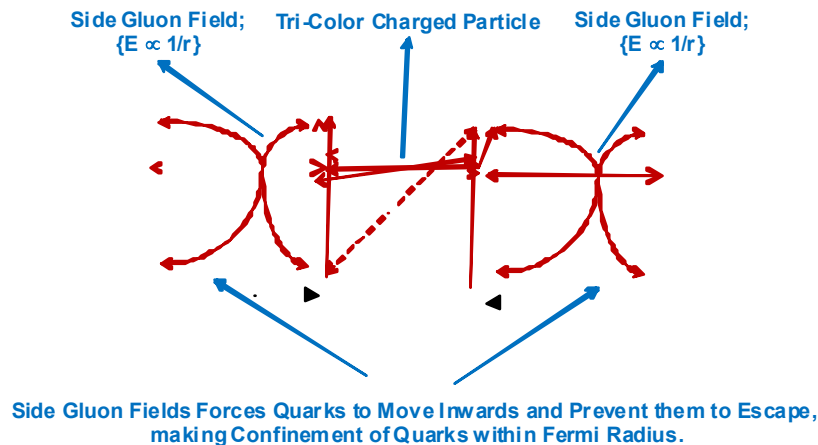

Fig -5. Quark Confinement and Side Gluons

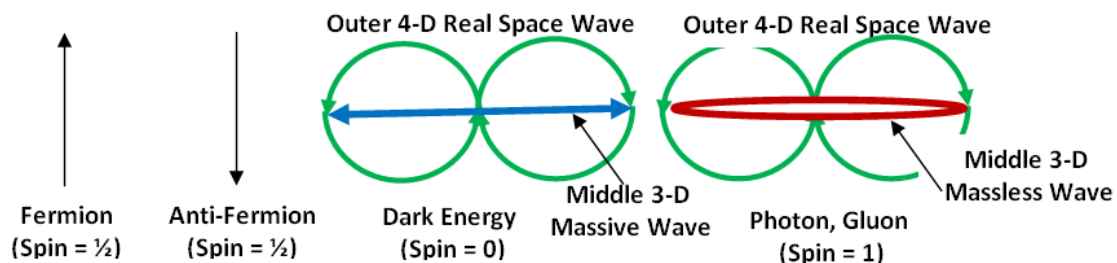

Fig. 6. Nature of Fermion and Bosons Particles

### Middle Fold

**Three Bottom Parts of Middle Fold:** There are 3 sub-folds of Middle Fold which are above Bottom Fold where each sub-fold includes one Type of Massive Leptons viz. Tau, Muon & Electron with their respective Massive Anti-Neutrinos (Right Handed) and Electro- Magnetic force carrying particles i.e. Photon. As Massive particles are defined by Straight Imaginary Line, it means imaginary curved line in 3-D real space are Massless particles or energy particles like, Gluons and Photons. It also shows that, these leptons should carry only Rest Mass and they gain their kinetic energy because of photons. Thus, every moving electron carries photon with it or electron does not have its own kinetic energy, but owns only Rest Energy. In atom, electron orbits around its nucleus (?). But, as electron is String like particle in  $4^{\text{th}}$  Imaginary dimension, hence instead of orbiting in circular manner around its nucleus, its field’s orbital path should look like shape of saddle or potato chip in order to include all 3 dimensions of real space (Wave like Pattern). In general, “Moving Field of Electron should follow Wave like pattern (path) even it is a

Similarly, if same pencil rotates in  $4^{\text{th}}$  Dimension, it should draw saddle shape like closed wave line to include all 3 dimensions.} Mass of each Fermion particle is fixed here, by means of their existence in their respective fold only. i.e, in this theory, we can calculate Mass of particles. In this theory, Fermions are defined as one String like Particle with one directional arrow (Spin =  $\frac{1}{2}$ ) while Bosons are made up of 2 closed curved lines connected to each other having rotational direction.

- In case of Spin = 1 type Boson particles (Gluon, Photon), out of these 2 lines; outer infinity shape ( $\infty$ ) like wavy real space line (4-D Wave) is responsible for Magnetic Field and is carrier of force between two fermions (viz. electron &/or positron). While Middle Wavy 3-D Imaginary Line, gives Spin=1 to that Boson particle and is responsible for Electric Field. Kinetic Energy (E) of Photons is directly proportional to Rotational Frequency ( $\nu$ ) of its 3-D imaginary Wave.



Higher Frequency means more compression of these both waves ( $E \propto \nu \propto 1/r$ ).

- For Spin = 0 type Boson particles (Dark Energy  $\leftrightarrow$  Constant Energy Density), out of these 2 lines; outer infinity shape ( $\infty$ ) like wavy real space line (Perfect Spherical 4-D Wave) is responsible for Magnetic Field. While Middle Straight Imaginary Line, gives Spin=0 & Mass to that Boson particle and is responsible for Constant Energy Density of Massive Dark Energy.

Thus, Bosons are like two Balloons connected to each other at their knot point and are pointing opposite to each other.

**Two Top Parts of Middle Fold**

It includes 2 sub folds for 3 Weakly Interacting Massive Neutrinos (Left Handed) and 2 type of Constant Energy Density particles viz. Dark Energy (Spin = 0). In their respective sub-fold, the energy density of all dark energy particles remains same (Constant). and it is achieved by means of “Division of Higher Constant Energy Density Dark Energy Particle, when it shifts from lower sub-fold of Middle Fold to upper sub-fold in such a way that every Less Constant Energy Density Dark Energy Particle looks similar to each other like Copy Cat.” There are 3 Types of “Dark Energy” particles (2 from Top parts of Middle Fold and 1 from Top Fold) such that “Constant Energy Density” of these particles decreases as they shift from lower part of Middle Fold to Top Fold. Shift in their position occurs with step by step unfolding of expanding Universe. And because of random shift in their position (as per availability of vacuum at their upper or lower fold), neutrinos along with them also shifts (oscillates) from one fold to other fold i.e. change in type of neutrinos (neutrino oscillations).

**Top Fold**

It includes “4<sup>th</sup> type of Neutrino” ( $\nu_y \cong 0$  eV) at Topmost part of this Top Fold, which yet to be discover. As said above, it also holds Very Less Constant Energy Density (Very Less Resistance) Soft particles viz. Dark Energy (Spin = 0) as well as Absolute Inner Light known as Massive Higgs Boson (Spin =0). It unites all four Fundamental Forces by passing through these 3 Main Folds vertically straight in 4<sup>th</sup> Imaginary Dimension. Dark Matter is Union of Higgs Boson (Spin=0) & its field, Higgs Field (Dark Energy, Spin =0). Their Union takes place, when mass of Higgs Boson particle becomes approximately zero because of their multiplication (Decrease in their mass from approx. 114 GeV to approx. 0eV) as well as creation of middle folds so that Union of them gives Dark Matter particles (Criss-Cross Shape Like; †). Dark Matter (Spin=0) is Massive particle, made of 2 massive particles: Higgs Boson particle and its field (Top Fold Dark Energy particle).

**Percentage distribution of matter and energy in the universe**

Every Dark Matter particle is connected with One Unified Fundamental Particle made up of 3 Imaginary Strings at Middle of Bottom Fold i.e. at Center of Nucleus known as “Tri-Color Charged Vector Boson Particle (Spin=0)” which we can call as “Shiv Matter”. It expands “Exponentially” outside of Nucleus (in Left Direction only) and every “Shiv Matter” always remains in connection with other “Shiv

Matter” (Merged with each other) which solves Flatness & Horizon problem. This particle is main source of Quarks, Leptons, Neutrinos, Anti-Neutrinos and Higgs Scalar Boson (Spin = 0) particles while Gluon (Spin =1) is Mother of Photons (Spin = 1), Dark Energy (Spin = 0) and Higgs Field (Spin = 0). At top fold, this Higg’s Boson (Approx. 0 eV) unites with its Higgs Field (K.E. approx. 0 eV) after completion of whole process of creation of Universe (i.e. creation of all folds) because of less resistance between them (Approx. 0 eV). Union of them gives Dark Matter particle (Spin = 0). Now, at the time of creation of Universe, Shiv Matter and His Field, both were made of equal energy (Total Energy of the Universe is always Zero; Total Energy of Universe = Rest Energy + Kinetic Energy = 0) i.e. approx. half TeV (500 GeV) for each of these particles. Now, in Universe, everywhere process of creation of particles remains same which says that, by analyzing % distribution of one quanta particle made of Union of this Shiv Matter and His Field, we can find out % Distribution of all Matters in the Universe as it is not possible to convert one particle into other particle (Because of Constraint on them like, Spin, Charge, Fold, Energy, type of particle – Fermion or Boson etc.). From current experiments and observations, we know that total % contribution of photons, gluons and matter (quarks, leptons, Hadrons – proton, neutron, neutrinos, anti-neutrinos) is very less (approx. 0.2- 0.4 %). So, let us calculate % Distribution of all matters in the Universe:-

“Negligible Qty [2 GeV (Proton + Neutron) out of 1 TeV  $\cong$  0.2%] of Ordinary Matter (Proton, Neutron & Electrons), 4% [Around 40 GeV out of 1 TeV] Bottom most Anti Neutrino, 22% [220 GeV out of 1 TeV] Dark Matter {11% Higgs Boson (110 GeV) & 11% (110 GeV) Higgs Field connected with it}, 39% {390 GeV out of 1 TeV} Dark Energy & 35% {350 GeV out of 1 TeV} Shiv Matter in terms of “Continuous lines of Tri-Color Charged Unified Particle” which spread Homogeneously everywhere at the time of “Creation of Universe” through Left Direction only in Instantaneous way.

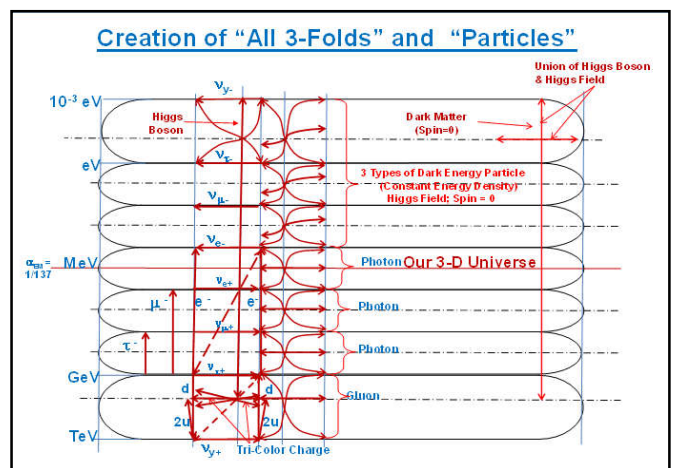

Fig. 7. Graviton, Dark Matter and 3 Types of Dark Energy

Electron in an atom and em forces (photons) between them

It is seen that “Electron (Middle Fold, Orbital Radius =  $10^{-10}$  m) and Proton (Bottom Fold, within Fermi Radius,  $10^{-15}$  m) are not connected to each other in an Atom by any means of Field Particle like Photon. Hence, there is no Attractive EM Forces between Electron and Proton in an Atom.” But, this Attractive

Force is Between Electron (Charge = - Q) and 4-D Downward Straight Line of Higgs Boson (Charge = + Q).

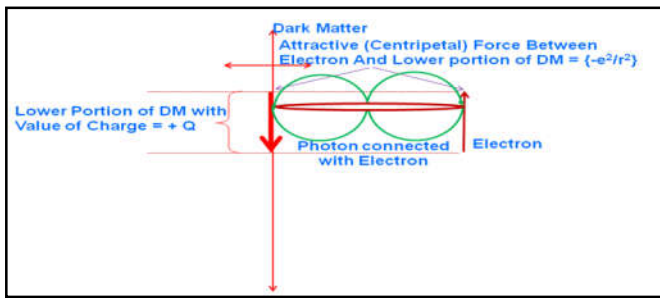

Fig. 8. Relation between Electron and Dark Matter in an Atom

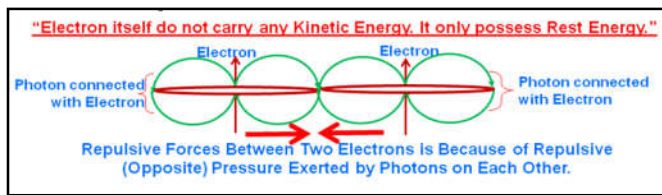

Fig. 9. Electron and EM forces (Photons) Between Them

**Inertia of mass (inertial force) and gluon (kinetic energy of massive object)**

When we apply Force on any Massive object, the force is transferred to that object by means of “EM Field Particle” i.e. photons or Force Carrying Boson Particles. This force is transferred to Dark Matter (Inner Straight Imaginary Line) through EM Field particles (photons) which are connected to it. Because of this Force, DM tends to move in applied force direction. But, it is connected with Hadrons (Tri-Color Charged Unified particle) at Bottom Fold and motion of these Hadrons due to motion of DM is resisted by Side (Surrounded) Gluons. Resistance (Inertial Force) given by Gluons is directly proportional to mass of Hadrons i.e. to Mass of that object. Thus,

**Gluon gives “Inertial Force to Mass”**

If applied force is more, Gluons get more compressed which in turn increases in Kinetic Energy of Gluon ( $E \propto 1/r$ ). Therefore, Applied Force is directly proportional to “Inertia of Mass” and “Acceleration” (Gain in Kinetic Energy) of the object on which force is applied. Also when we apply force, force carrying particles (Viz. photons) never transfer from force applying object to force receiving object. Instead of this, the moment when force applying object contacts with other object, it’s gluons expand in direction opposite to object’s direction of motion, which in turn decreases gluon’s K.E. ( $E \propto 1/r$ ) and therefore motion of that object is stopped or reduced and at the same time, the reactive force is applied on the object’s Tri-Color Charged Unified particle (Mass of that object) by gluons. Thus, Newton’s third law of motion (Every Action has equal and opposite reaction) is due to force carrying resisting particle; Gluons. If by any means, it becomes possible to remove Gluons from Hadrons or to reduce its percentage in nucleus, then, “Inertia (Resistance) of Mass” will reduce which in turn will increase “Acceleration of that Object for given applied Force. ( $F = m \cdot a$ )”. With no presence of Gluons inside nucleus of atom, its Inertia to Mass i.e. inertial Force will become zero.

**As per “Einstein’s Equivalence Principle (Inertial Mass = Gravitational Mass)”, same Gluons must be responsible for increase in kinetic energy of any object (Mass = m) in presence of Gravitational Field of other Massive Object like Earth (Mass = M) during Free Fall**

For Conservation of Energy, the Earth should release its Kinetic Energy (Slow down of Earth’s Kinetic Energy or rotation) in terms of decrease in kinetic energy of Gluons of its matter. This decrease in Kinetic Energy of the Earth must be exactly Equal to Gain in Kinetic Energy of that object (Mass = m).

**Understanding gravity force through particle physics**

Dark Matter with very less energy density (at Top Fold) are like “Soft Ball” while Hadrons (at Bottom Fold) which defines Mass of any atom are like “Hard Core”. When we will combine them, we can imagine a 4-Dimensional Perfect Spherical ball having soft outer surface while hard core at its center similar like “Seed in Fruit”. To define Gravity Effect, let us keep such plenty of Balls in a Huge Spherical Container. We will notice that, outer surface of balls which are near center of that container gets Compressed due to weight of balls (because of Hard Core inside every ball). This Compression of “Outer Surface of Ball” because of Total Weight of Balls is nothing but, “Curvature of Space-Time due to presence of Massive Object”.

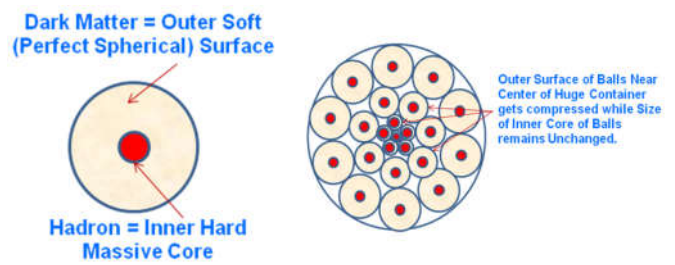
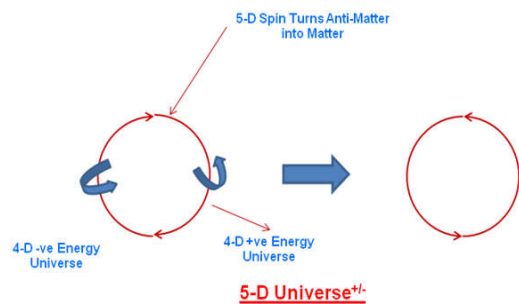

Fig. 10. Dark Matter as 4 Dimensional Sphere (Soft Outer Surface with Hard Core Inside)



**Matter - anti matter asymmetry and spin in 5-d universe**

Our 3 Folds 4-Dimensional Universe is made up of +Ve mass-energy (Heat) and it is connected with its reflection or mirror image i.e. 4-Dimensional -Ve mass-energy (Antimatter, Cold) Universe. Both Universes are tied with each other and as a whole; they make 5-D Universe+/- . Spin in 5-D Universe+/- converts Anti-Matter into Matter and vice a versa at Hadron level (Neutron) itself with no violation of Laws of Energy and Charge Conservation. Thus, all Anti-Matter transferred into

Matter initially; hence, no need of “Matter- Anti Matter Asymmetry”.

### Conclusions

In this Theory, “Imaginary Straight Line” is equivalent to “Mass of particle”, while any curved Imaginary line shows Massless equal to Spin 1 properties of Boson particles viz. Gluons and Photons. Thus, here Massless is directly connected with Spin=1 property of photon which is already proved in QED theory. Not only this, it is cleared here, that photon (EM Wave) is not a Single particle, but it is made of 2 lines: outer 4-D Real Space Infinity Shape Line (responsible for Magnetic Field, acts as Force Carrier through resistance to motion and is probabilistic in nature like smoke in closed volume) and other 3-D Closed Curved Imaginary Line (Massless = Spin 1).

Also, true nature of Dark Matter (Union of Higgs Boson and its Field = Top Fold Dark Energy) and Dark Energy is revealed by showing their Massive = Spin 0 properties. Also, arrangement of all particles in 3-Folds way not only simplifies particle physics theory but, also gives wide scope towards “Beyond Theory of Standard Model” within TeV range. Finally Author concludes that, with advancement in this Theory, new era of Science will begin for better future of mankind.

### REFERENCES

- Harald Fritzsch, “The Fundamental Constants, A Mystery of Physics”, [World Scientific Pub. Co., 2009]  
Aitchison, I J R.,A J G Hey, “Gauge Theories in Particle Physics”, Vol. 1

\*\*\*\*\*